

SINGLE HOLE MOUNT LAVATORY FAUCET

Description

- Single lever, single hole mount
- All brass pop-up drain assembly
- Optional deck plate included

Flow & Valving

- See Chart

Standards

- ASME A112.18.1
- CSA B125
- NSF 61-9
- Energy policy act of 1992
- Listed IAPMO/UPC
- ADA Accessibility Guidelines for Buildings and Facilities - 4.27.4 Controls and Mechanisms 

Warranty

Danze products are covered by a manufacturer's limited "lifetime" warranty for manufacturing defects.



d222158
PARMA™



Available Colors & Finish

- Chrome
- Brushed Nickel (BN)

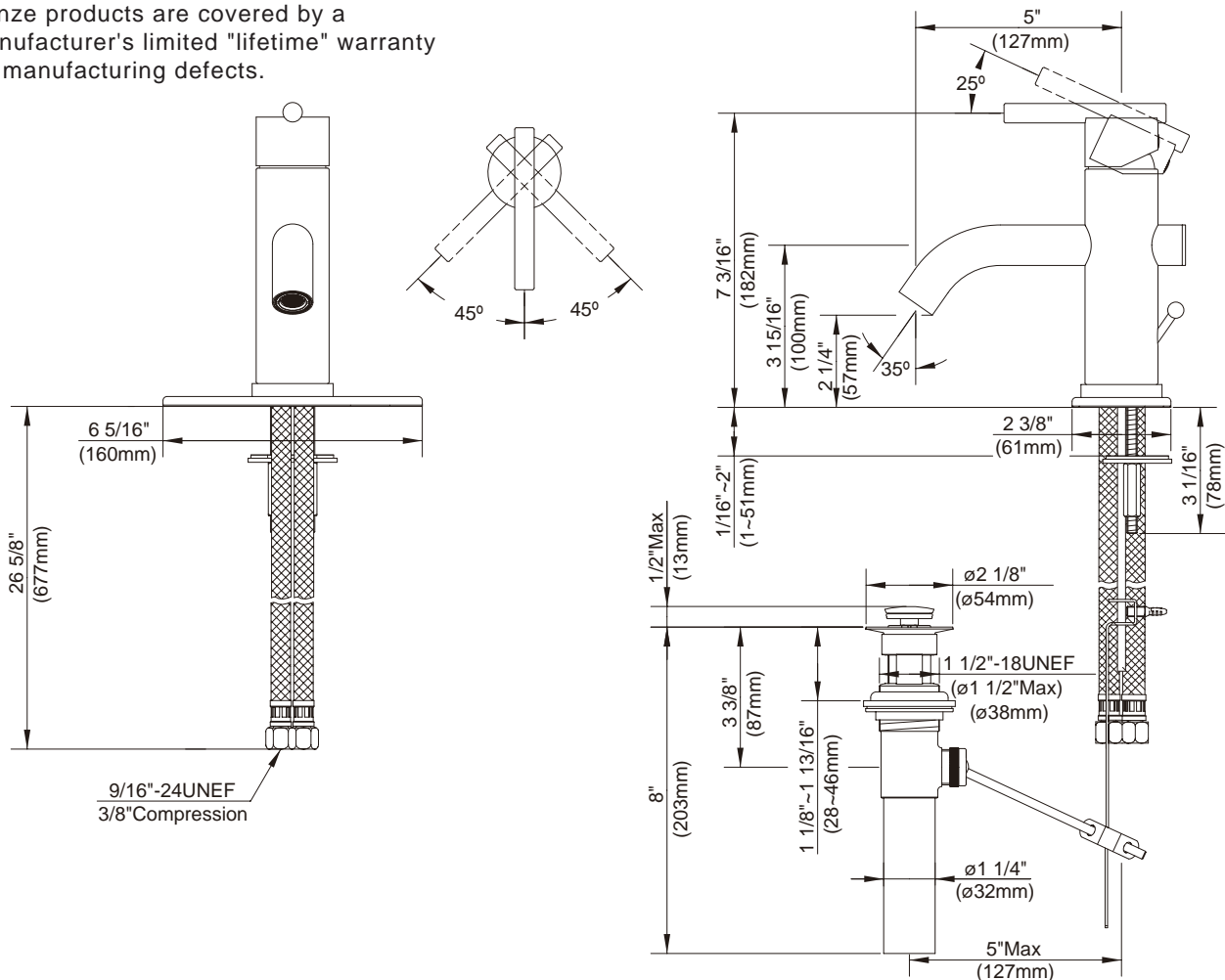
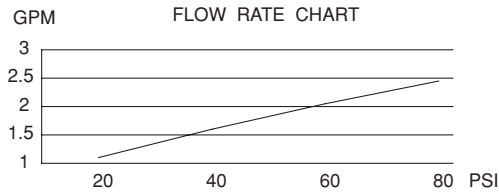

Specific Features: _____ Submitted Model No.: _____

SD222158/01-07.01